



31710 12" Combination Square.



31900 Mini Block Plane w/ Hand Adjustment.
31905 Block Plane w/ Knob.



31910 Block Plane w/ Hand Adjustment.
31915 Block Plane w/ Adjustable Knob.

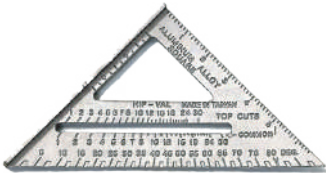

31720 Square Speed.



31490 Half Round Protractor.



31930 Spoke Shave, Adjustable Cutter.



31348 48" Aluminum Drywall T-Square.



31920 Smooth Plane.

Flexible stainless steel, polished finish & acid-etched surface. Precise & easy to read, professional quality.



31443 12" (30cm) Stainless Steel Straight Ruler.
31444 18" (45cm) Stainless Steel Straight Ruler.
31446 24" (60cm) Stainless Steel Straight Ruler.

Durable & precise aluminum base with stainless steel blade. Metric system on front & SAE system on back. Blade is polished, anodized or yellow coating finish. Tested within 90+/- 0.2 degree.

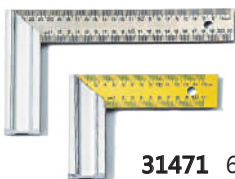

31471 6" (150mm) Aluminum Square.
31472 8" (200mm) Aluminum Square.
31473 10" (250mm) Aluminum Square.
31474 12" (300mm) Aluminum Square.

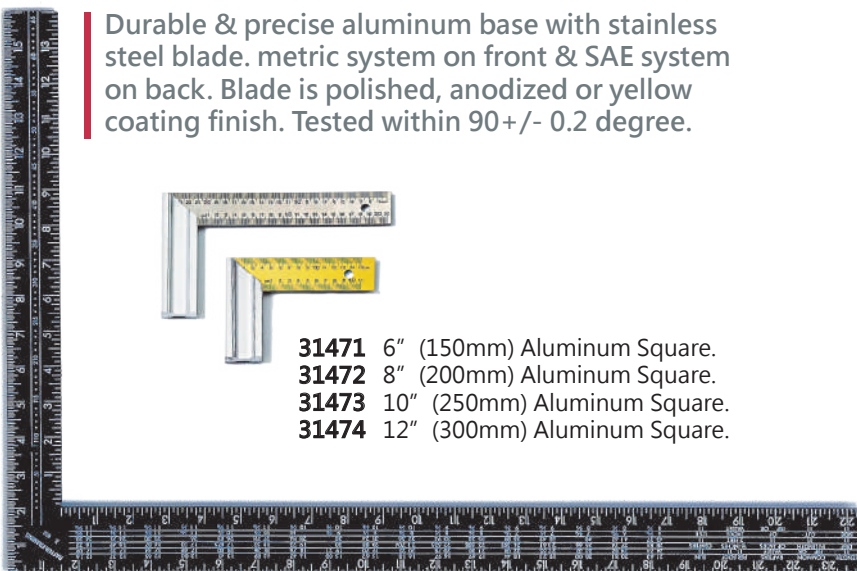

31762 8" x 24" Square.
31764 16" x 24" Square.

Carpenter Tools

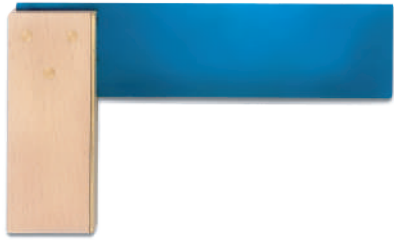

31461 Try Square, Blue Steel Blade.

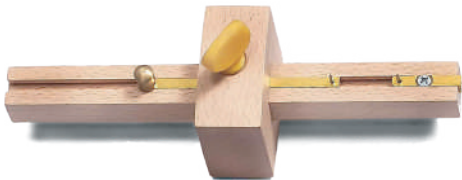

31480 Mortice Gauge.

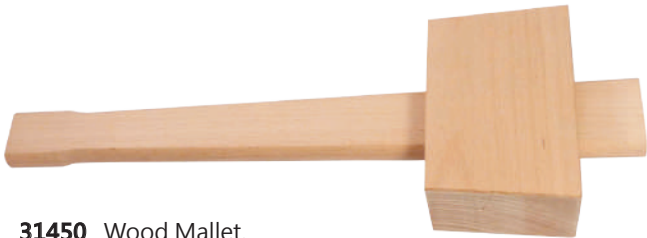

31450 Wood Mallet.



31770 Sliding Bevel.
31775 Sliding Bevel, w/Spirit.
37716 Adjustable Bevel, Blue Steel Blade, Wood Handle.

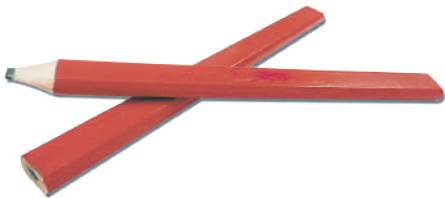

31485 Carpenter Pencil.



Lock Installation Kit

31950 2-1/8" (54mm) Hole Saw w/9mm Auger Bit for Large Lockset Hole, 7/8" (22mm) Auger Bit For Latch Hole.



31130 Miter Saw Set.



31120 Hand Saw.



31820 Nail Puller.



31800 Pry Bar 9-1/2" .



31826 Base Moulding and Tackless Strip Lifter.



31280 Wood Chisel, Soft Grip Handle.



31290 Wood Chisel, Wood Handle.



31850 Flat File, Soft Grip Handle.

Automotive and wood working hobbyist preparing tool. Use to shave, smooth, trim, shape and form a variety of materials for regular or decorative work. Metal alloy & enameled or plastic body with high carbon steel and heat treated blade.



14800 Plane Type Surface Forming File.



14810 File Type Surface Forming File.



14820 Two-way Surface Forming File.

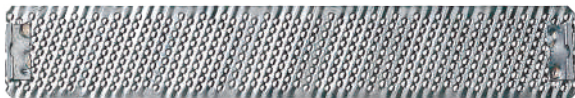

14805 10" x 1-5/8" Replacement Flat Blade.
14806 10" x 1-5/8" Replacement Half Round Blade.



14831 Pocket Type Surface Forming File.
14835 5-1/2" x 1-5/8" Replacement Flat Blade.



14850 Shaver Tool, Plastic.
14855 10" x 2-1/2" Replacement Curve Blade.



14860 Handy Type Surface Forming File, Plastic.
14865 3" x 1-5/8" Replacement Curve Blade.



14870 Beetle Type Surface Forming File, Plastic.



14880 Slender Type Surface Forming File, Plastic.
14885 6" x 1/2" Replacement Flat Blade.



14890 Plane Type Surface Forming File, Plastic.